

## DRESSUP

Wall Solution

Design by García Cumini

- **INSPIRATIONS**

Visual lightness and technology are the inspiring principles that promoted an inversion of the traditional storage paradigm, resulting in units that are developed vertically and preserve a perception of great lightness and freedom. That's what inspired Dressup: this system can be easily customised and used in endless ways: on the kitchen splashback, in the bathroom and in the hall.

- **DESCRIPTION**

A modular wall system made up of elements that are only 22 cm deep and feature sophisticated solutions such as anodised aluminium profiles that support the glass shelves and accessory holders. They can be with or without doors. The profiles are provided with grooves to accommodate lighting and sound diffusion cables. Numerous finishes and combinations are possible with other Cesar models.



## DRESSUP

Wall Solution

Design by García Cumini

### • DIMENSIONS AND GENERAL CHARACTERISTICS

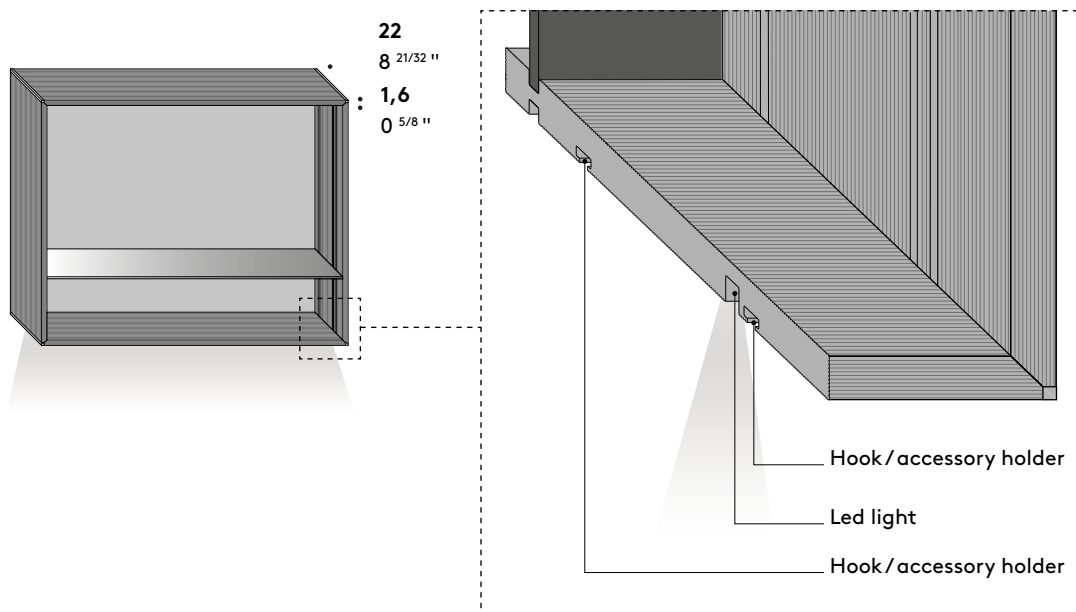

### • GENERAL RULES

01\_The carcass is composed of anodised aluminium "millerighe" profiles made using Cesar's L-shaped section. They are available in Nero, Champagne and Bronzo finishes. The back panel is customisable in the Cesar finishes ranging from melamine to lacquer and from stainless steel to natural stone.

02\_Fumè and Bronzo finish, 10-mm thick glass shelf matching the width of the carcass. Each module will be supplied with a standard number of shelves. Each shelf will be fitted at a 12 cm distance from the other. For 150 and 180 cm lengths, the shelves will be propped up at the centre using a glass support to prevent bending.

03\_Doors are composed of an extruded aluminium frame with fronts available in the many Cesar finishes.

04\_ The upper side of the Dressup frame can be covered with an upper top in the Cesar finishes.

05\_If Led lights are fitted, please plan for a suitable quantity of electric sockets depending on the project (see price list).

06\_ The accessories, glass shelves, top panel and sound system are optional

07\_If accessories are fitted in the lower section of Dressup, the minimum distance from the top must be greater or equal to 50 cm.

08\_If there are no accessories we recommend leaving a minimum gap of 5 cm from the top of base units.

09\_If the unit is installed near the ceiling it is advisable to leave an empty space of at least 12 cm to make adjustments from above if possible.

10\_The Dressup project does not include non-standard modules.

## DRESSUP

Wall Solution

Design by García Cumini

### • MODULE SIZES

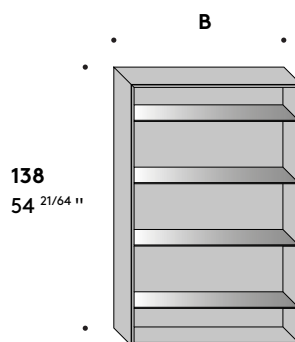
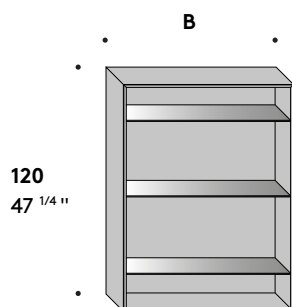
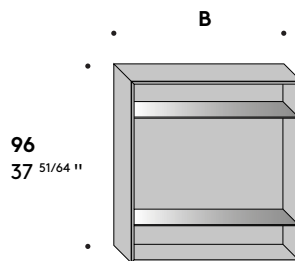
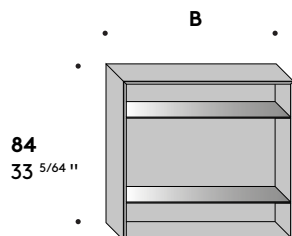
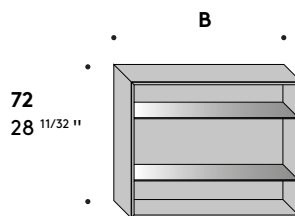
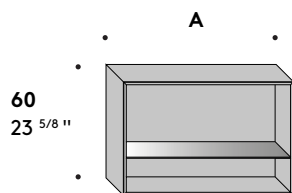
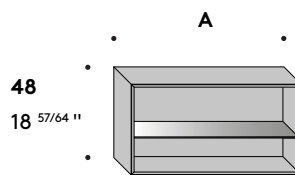
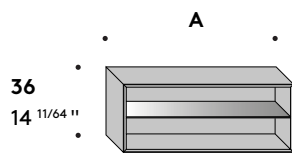

**A 45 - 60 - 90 - 120 - 150 \* - 180 \***  
17 <sup>23/32</sup> - 23 <sup>5/8</sup> - 35 <sup>7/16</sup> - 47 <sup>1/4</sup> - 59 <sup>1/16</sup> - 70 <sup>55/64</sup> "

**B 30 - 45 - 60 - 90 - 120**  
11 <sup>13/16</sup> - 17 <sup>23/32</sup> - 29 <sup>17/32</sup> - 35 <sup>7/16</sup> - 47 <sup>1/4</sup> "

**NOTE:** Non-standard modules are not available.

The shelves shown for each module are those supplied as standard and they can be fitted in the desired position.

\* 150 and 180 cm long shelves will come with a specific, central glass support.

# C E S A R

## DRESSUP

Wall Solution

Design by García Cumini

### • SIZES OF MODULES WITH DOORS

#### FRAMED HINGED DOORS\*

**30 - 45 - 60**  
17 <sup>23/32</sup> - 23 <sup>5/8</sup> "

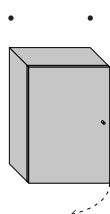

**90 - 120**  
35 <sup>7/16</sup> - 47 <sup>1/4</sup> "

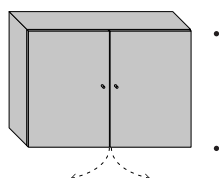

**60 - 72 - 84 - 96 - 120 - 138**  
23 <sup>5/8</sup> - 28 <sup>11/32</sup> - 33 <sup>5/64</sup> - 37 <sup>51/64</sup> - 47 <sup>1/4</sup> - 54 <sup>21/64</sup>

#### FRAMED GLASS DOORS

**45 - 60**  
17 <sup>23/32</sup> - 23 <sup>5/8</sup> "

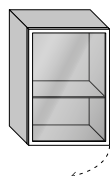

**90 - 120**  
35 <sup>7/16</sup> - 47 <sup>1/4</sup> "

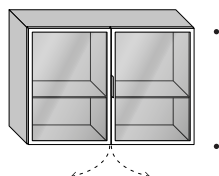

**60 - 72 - 84 - 96 - 120 - 138**  
23 <sup>5/8</sup> - 28 <sup>11/32</sup> - 33 <sup>5/64</sup> - 37 <sup>51/64</sup> - 47 <sup>1/4</sup> - 54 <sup>21/64</sup>

#### FRAMED DROP-DOWN DOORS \*

**A**

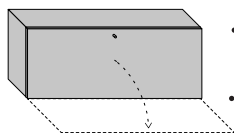

**36 - 48**  
14 <sup>11/64</sup> - 18 <sup>57/64</sup> "

**A 60 - 90 - 120 - 150 - 180**  
23 <sup>5/8</sup> - 35 <sup>7/16</sup> - 47 <sup>1/4</sup> - 59 <sup>1/16</sup> - 70 <sup>55/64</sup> "

\* Not available in natural stone, engineered stone, lacquered glass and lacquered metal.

### • HANDLES

01\_ The integrated handle flush with the frame can be installed on framed glass doors.

02\_ The integrated handle flush with the frame or the knobs can be installed on framed and hinged panel doors.

## DRESSUP

Wall Solution

Design by García Cumini

### • OPTIONAL ELEMENTS

#### SMALL ACCESSORY HOLDER

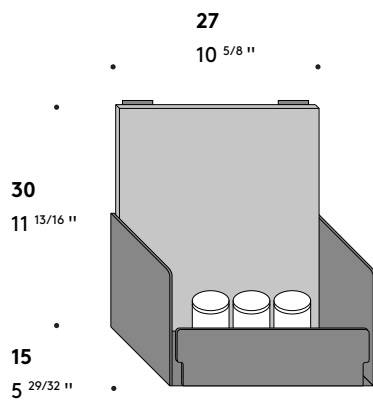

#### BIG ACCESSORY HOLDER

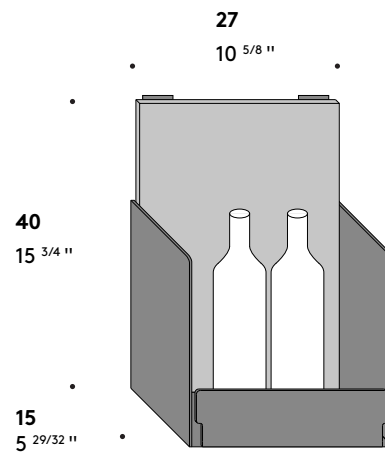

#### SQUARE HOOK



#### CURVED HOOK



#### CLOTHES HOOK

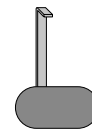

#### STEMWARE RACK for glass shelves

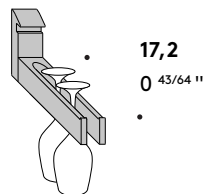

### • FINISHES

#### STRUCTURE

Black anodised aluminium  
Champagne anodised aluminium  
Bronze anodised aluminium

#### BACK PANEL

Oak wood veneers (all)  
Elm veneers (all)

#### STEMWARE RACK

Rovere Corvino

## DRESSUP

Wall Solution

Design by García Cumini

### • OPTIONAL ELEMENTS

#### GLASS SHELVES

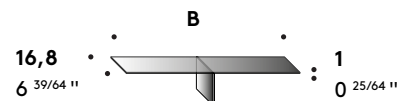
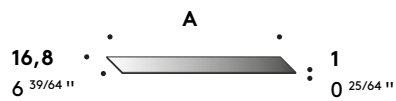

A 45 - 60 - 90 - 120 - 150 - 180  
 17 <sup>23/32</sup> - 23 <sup>5/8</sup> - 35 <sup>7/16</sup> - 47 <sup>1/4</sup> - 59 <sup>1/16</sup> - 70 <sup>55/64</sup> "

B 150 - 180  
 59 <sup>1/16</sup> - 70 <sup>55/64</sup> "

#### BACK PANEL\*

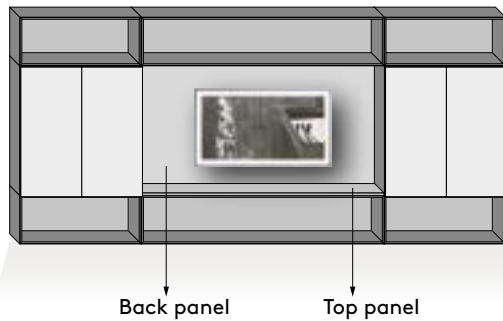

#### TOP PANEL

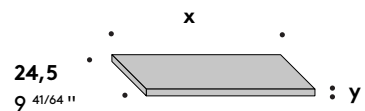

x to be ordered per linear metre (see Cesar tops)  
 y the thickness varies depending on the material

\* Optional back panel to extend arrangement options.  
 The dimensions change depending on the material chosen.

#### EXTERIOR LIGHTING Lower \*

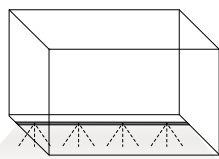

#### INTERIOR LIGHTING Side and/or upper \*

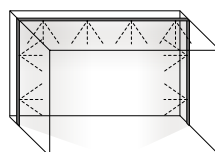

#### SOUND SYSTEM

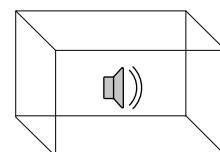

\* available with motion sensor or remote control.

# C E S A R

## DRESSUP

Wall Solution

Design by García Cumini

- **DRESSUP PROFILE FINISHES**

Ribbed black  
Ribbed Champagne  
Ribbed bronze

.....

- **DOOR PANEL FINISHES**

All Cesar finishes (except for natural stone, engineered stone, glass and lacquered metals)

Fumè glass with or without Ash fabric  
Bronzo glass with or without Oak fabric

.....

- **GLASS DOOR FRAME AND HANDLE FINISHES**

Brushed black  
Brushed bronze  
Brushed Champagne

.....

- **SHELF FINISHES**

Fumè glass  
Bronzo glass

.....

- **KNOB FINISHES**

Polished nickel  
Gloss black nickel  
Satin Champagne  
Satin bronze

- **BACK PANEL FINISHES**

Art Collection digital print  
Rear-lit Solaris panel  
Mirror  
Melamine  
Technomat  
Technogloss  
Fenix  
Unicolor HPL  
Gloss and silk-effect lacquers  
Structured lacquers  
Wood veneers  
Gloss and etched glass  
Metallic effect lacquers  
Metals  
Ceramics  
Natural stone  
Engineered stone

.....

- **TOP PANEL FINISHES**

Melamine  
Technomat  
Technogloss  
Fenix  
Unicolor HPL  
Gloss and silk-effect lacquers  
Structured lacquers  
Wood veneers  
Gloss and etched glass  
Metallic effect lacquers  
Metals  
Ceramics  
Natural stone  
Engineered stone

**IMPORTANT:**

Notes, dimensions and finishes are indicative

# C E S A R

## DRESSUP

Wall Solution

Design by García Cumini

- EXAMPLES OF KITCHEN ARRANGEMENTS

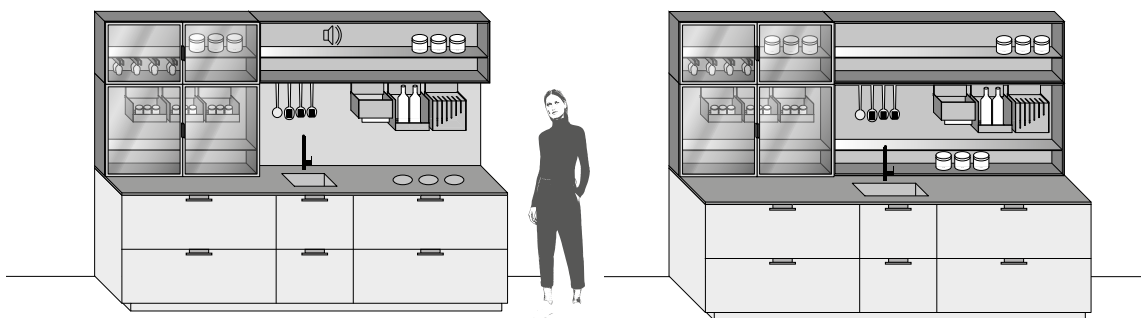
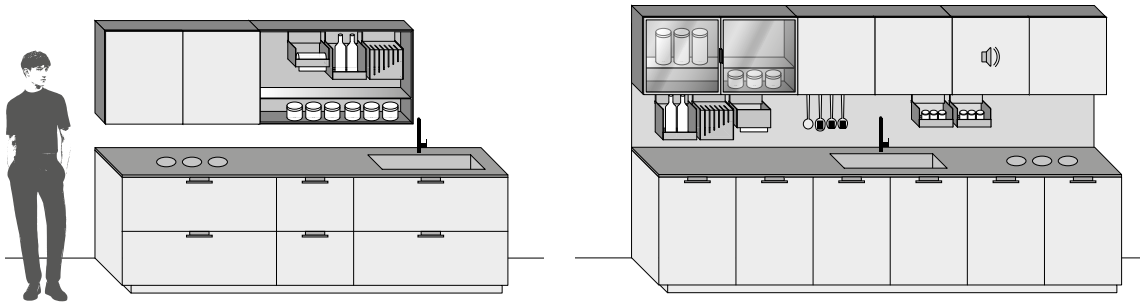
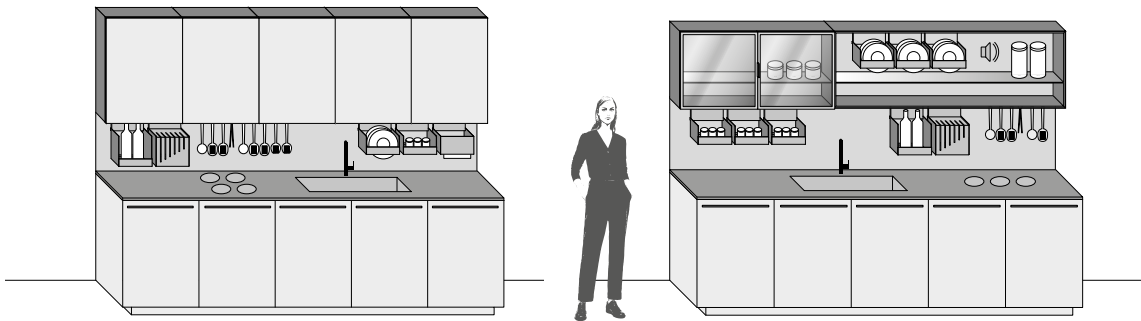



# C E S A R

## DRESSUP

Wall Solution

Design by García Cumini

### • EXAMPLES OF KITCHEN ARRANGEMENTS

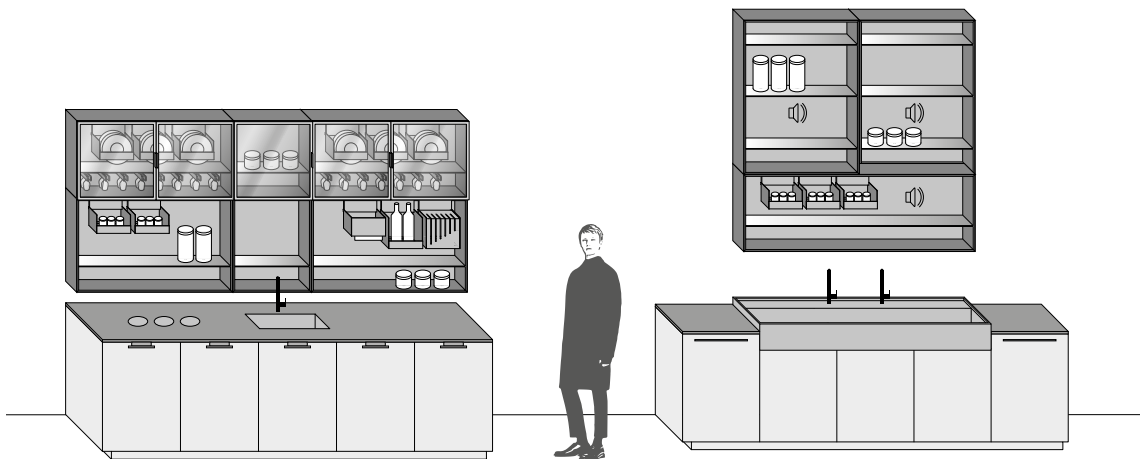
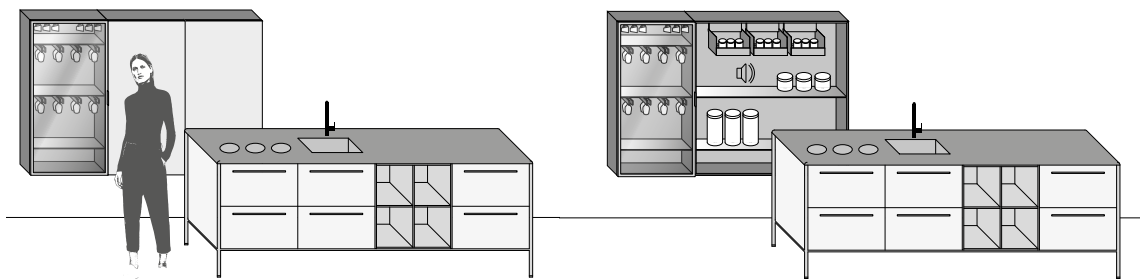
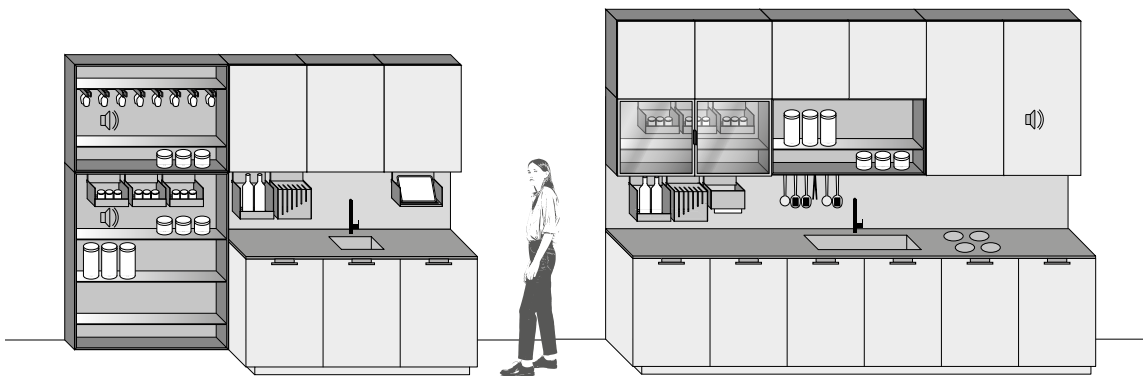

# C E S A R

## DRESSUP

Wall Solution

Design by García Cumini

- EXAMPLES OF KITCHEN ARRANGEMENTS

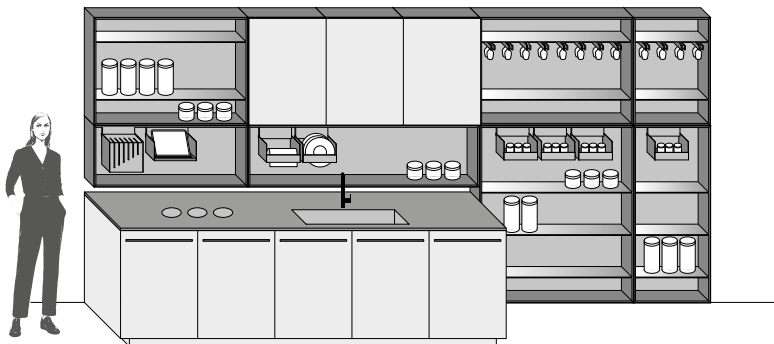
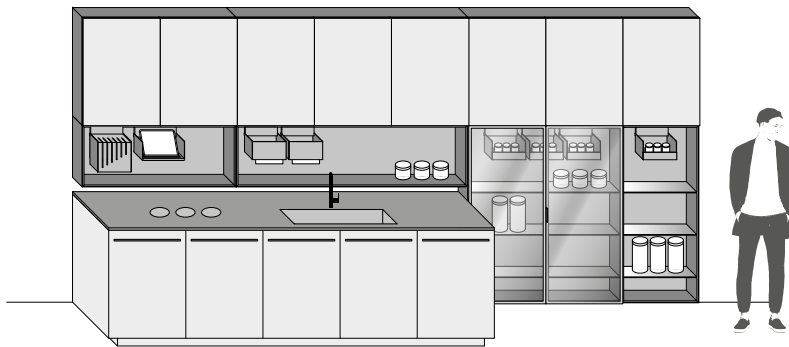

# C E S A R

## DRESSUP

Wall Solution

Design by García Cumini

- EXAMPLES OF KITCHEN ARRANGEMENTS

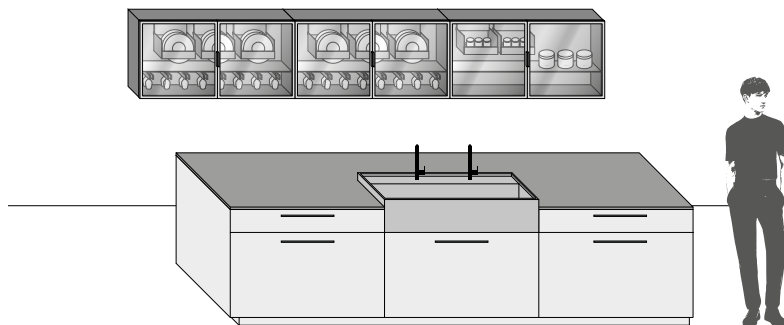
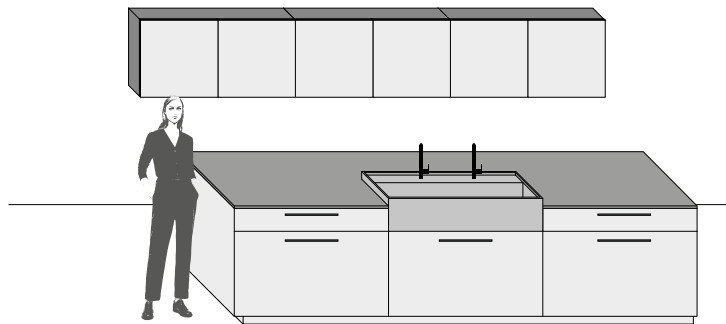
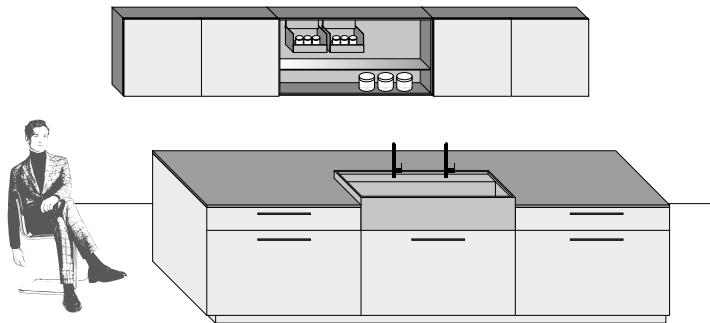

# C E S A R

## DRESSUP

Wall Solution

Design by García Cumini

- EXAMPLES OF KITCHEN ARRANGEMENTS

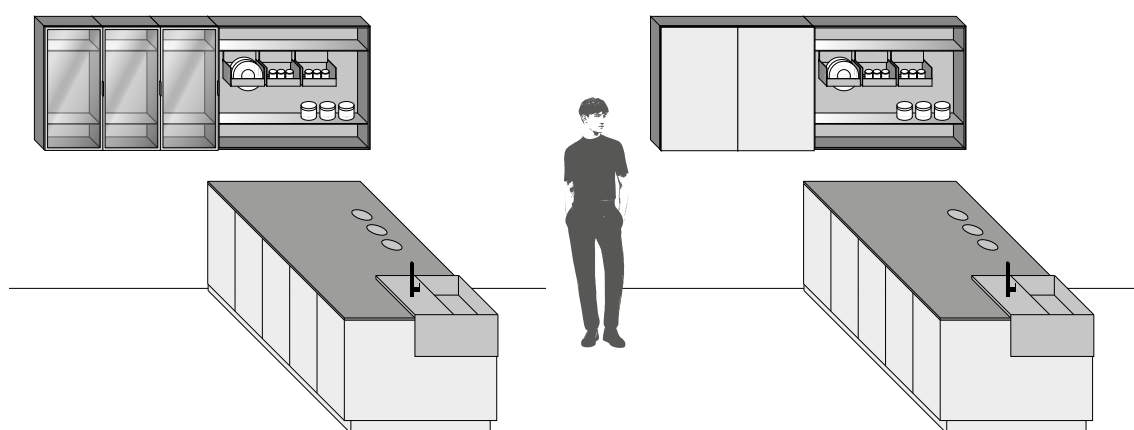
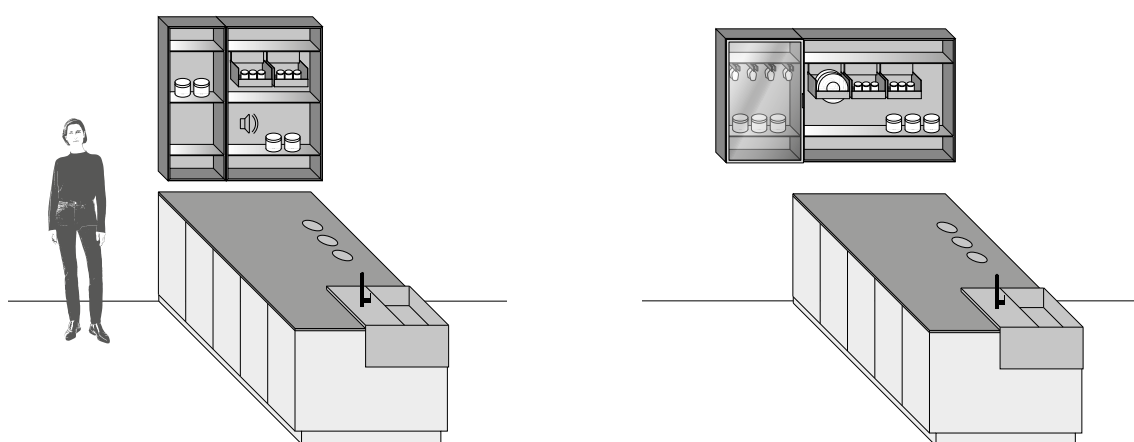

## DRESSUP

Wall Solution

Design by García Cumini

- EXAMPLES OF KITCHEN ARRANGEMENTS

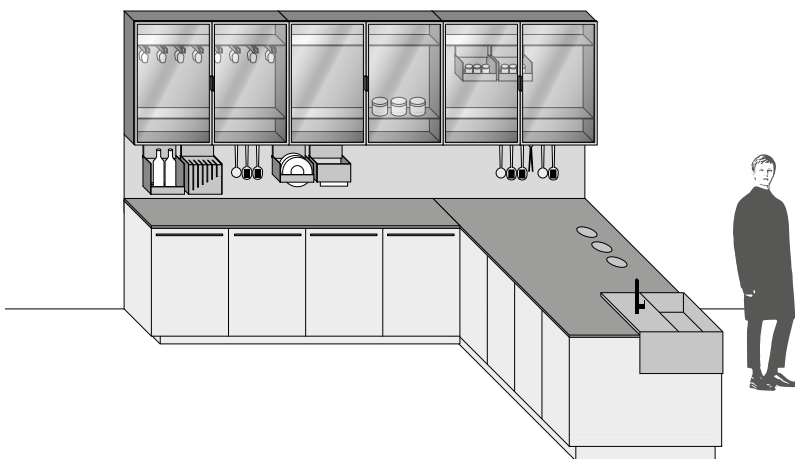
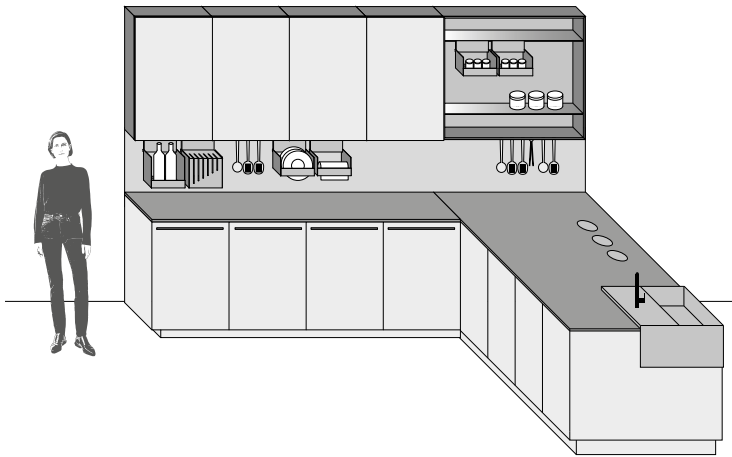

# C E S A R

## DRESSUP

Wall Solution

Design by García Cumini

- EXAMPLES OF KITCHEN ARRANGEMENTS

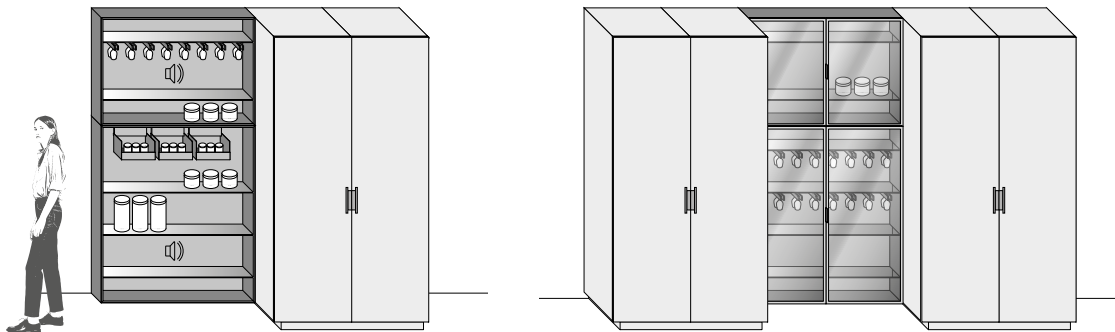
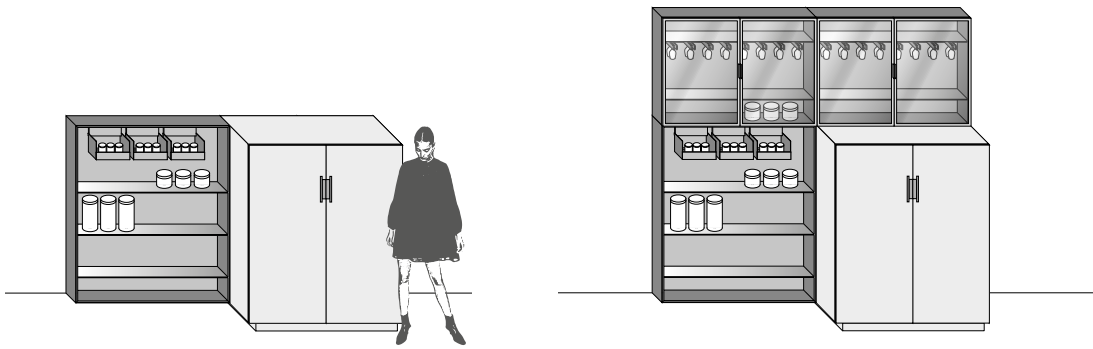
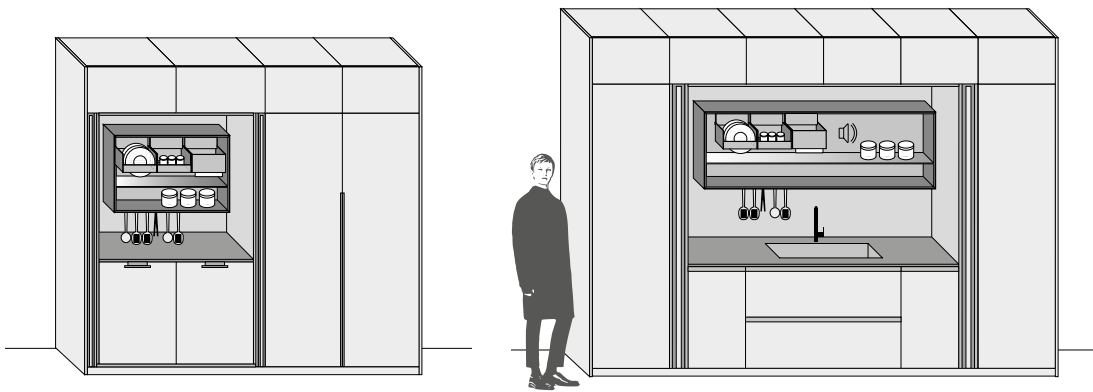

# C E S A R

## DRESSUP

Wall Solution

Design by García Cumini

- EXAMPLES OF LIVING / DINING ROOM ARRANGEMENTS

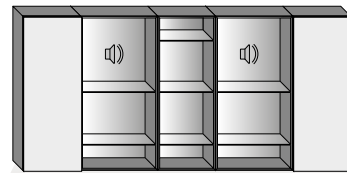
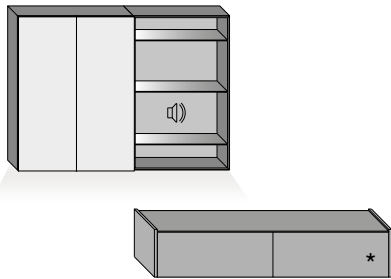
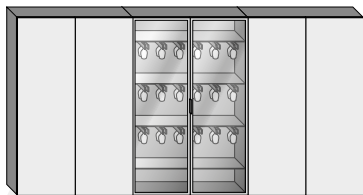
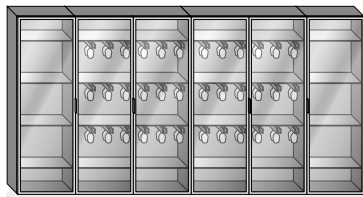

\* GAP – Living room furniture

## DRESSUP

Wall Solution

Design by García Cumini

- EXAMPLES OF LIVING / DINING ROOM ARRANGEMENTS

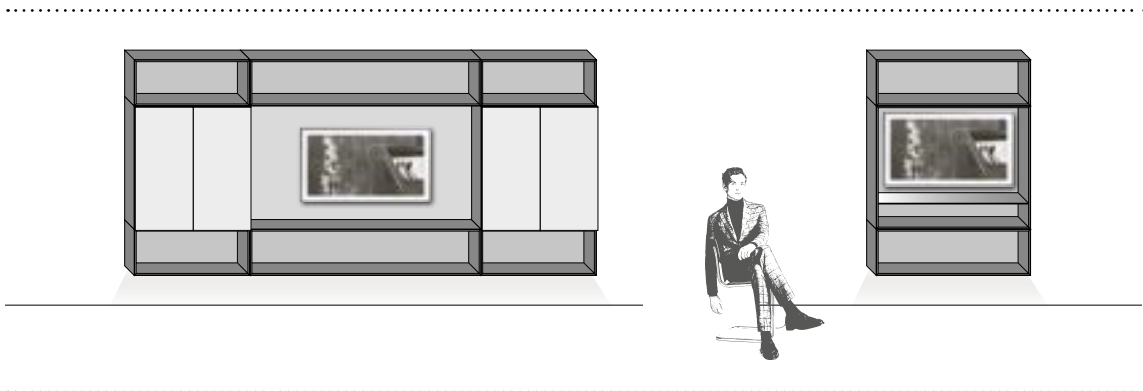
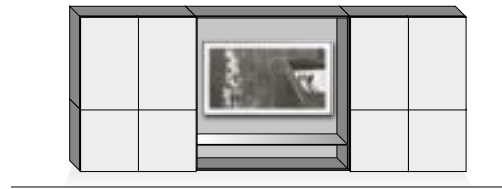
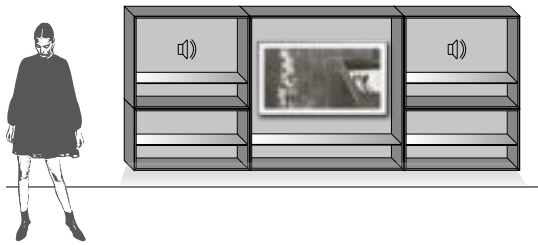



## DRESSUP

Wall Solution

Design by García Cumini

- EXAMPLES OF LIVING / DINING ROOM ARRANGEMENTS

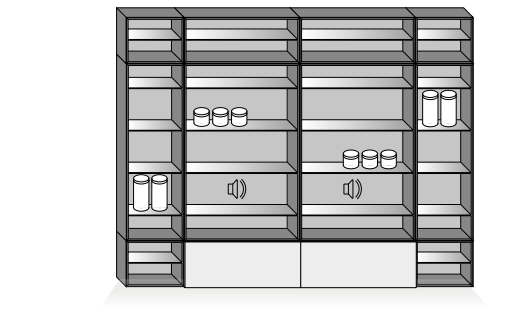
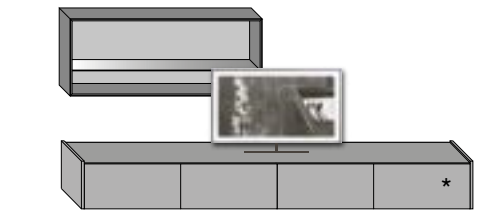
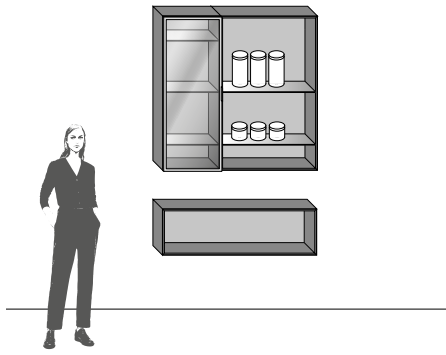

\* GAP – Living room furniture

C E S A R

## DRESSUP

Wall Solution

Design by García Cumini

- EXAMPLES OF LIVING / DINING ROOM ARRANGEMENTS

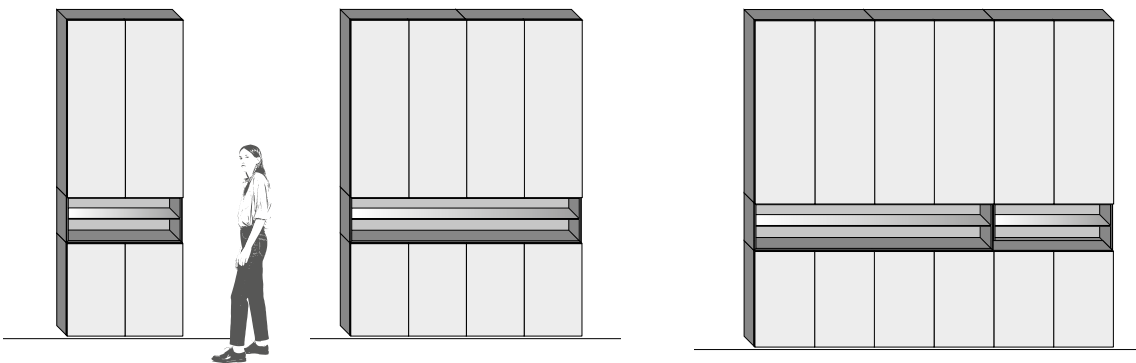
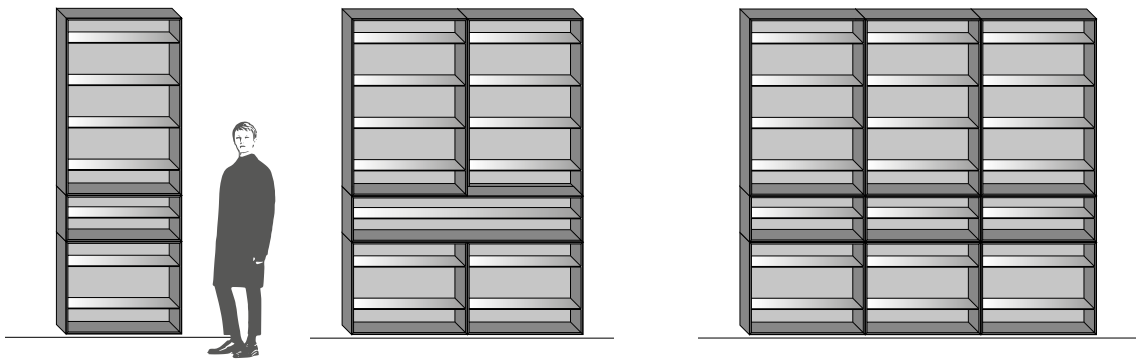

# C E S A R

## DRESSUP

Wall Solution

Design by García Cumini

- EXAMPLES OF LIVING / DINING ROOM ARRANGEMENTS

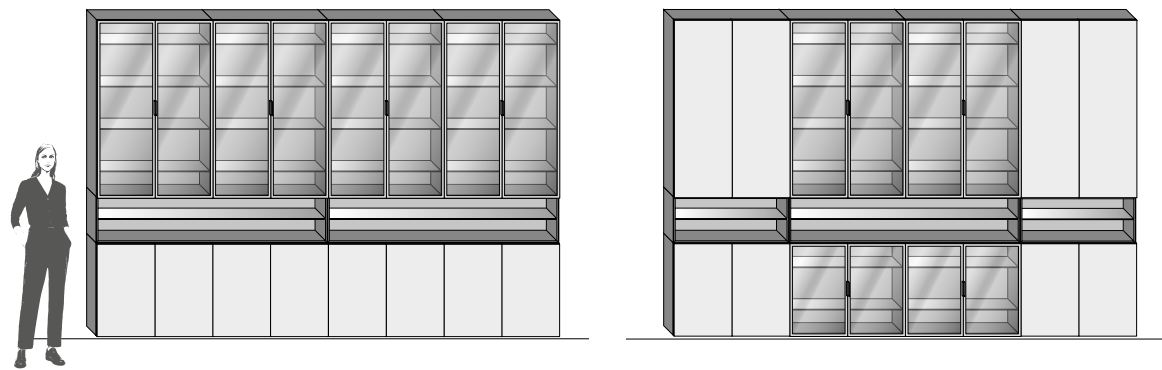
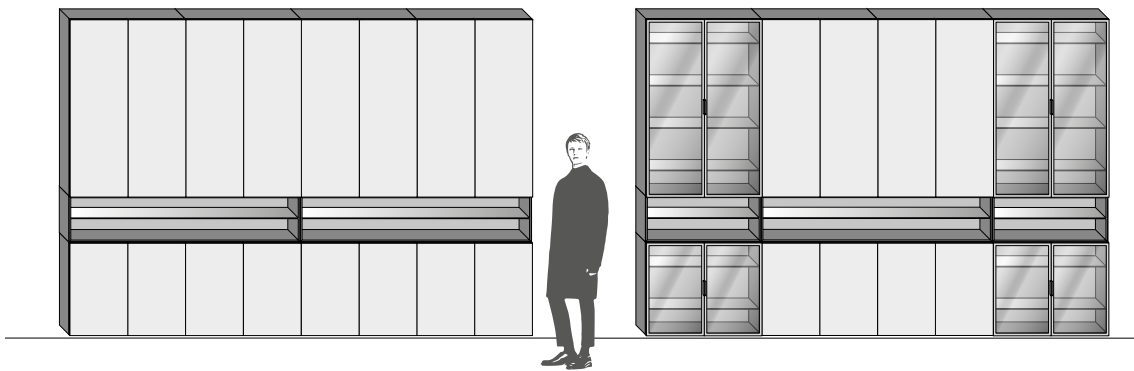

## DRESSUP

Wall Solution

Design by García Cumini

- EXAMPLES OF LIVING / DINING ROOM ARRANGEMENTS

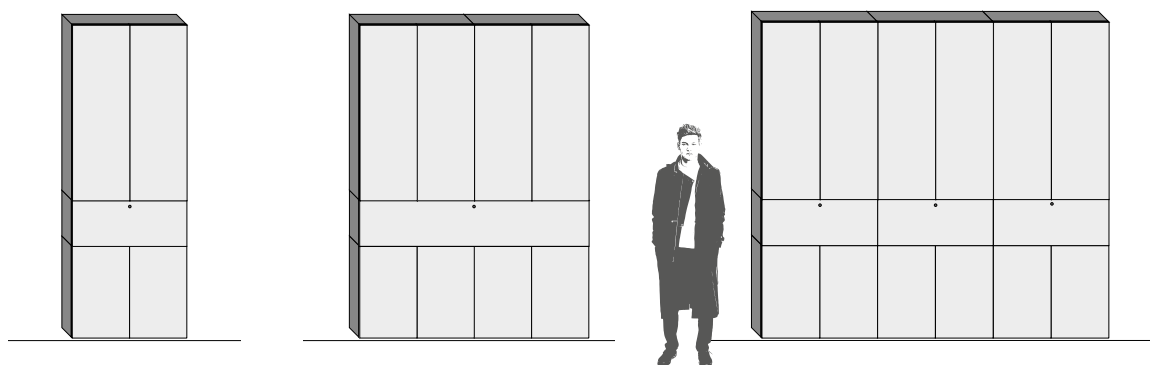
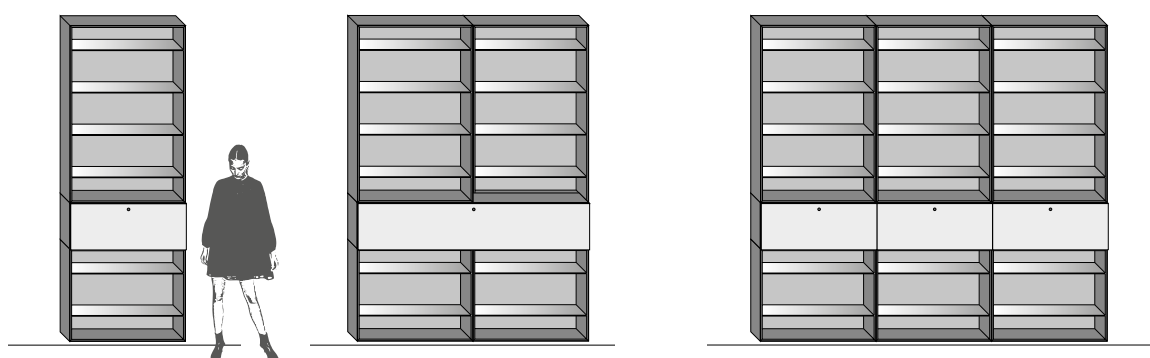

# C E S A R

## DRESSUP LINE

Wall Solution

Design by García Cumini

- **INSPIRATIONS**

Making the most of the gap between base and wall units in a way that takes up the least possible space in depth. The DressUp Line has been created to reach this goal. It's a sleek and linear shelving system for splashbacks that combines functionality with aesthetic minimalism.

- **DESCRIPTION**

An element belonging to the DressUp system that stands out for its linear lines and consists of a shelf and a back panel connected by technological elements.

This is a comprehensive system designed to accommodate all the kitchen accessories used every day in such a way as to take up the least possible space and volume.



## DRESSUP LINE

Wall Solution

Design by García Cumini

### • DIMENSIONS AND GENERAL CHARACTERISTICS

Dressup Line

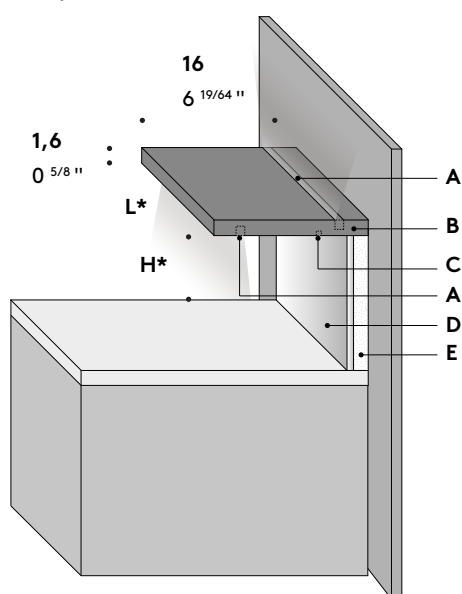

DressUp Line with shelf overlay (optional)

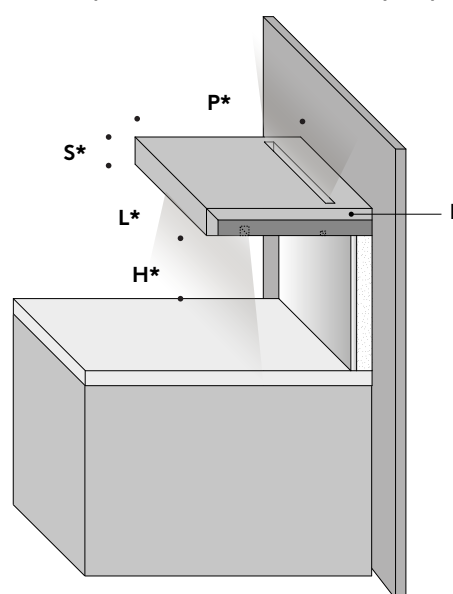

- A Led lighting
- B DressUp Line edge
- C Hook/accessory holder

- D Back panel
- E Back panel supporting panel (where necessary)
- F Shelf overlay (optional)

### • NOTES

01\_The DressUp Line module is composed of an anodised aluminium "millerighe" shelf available in Nero, Champagne and Bronzo finishes and of a back panel. The module is attached to the wall by means of a fastening system created by Cesar. The shelf and the back panel cannot be supplied separately.

02\_The 22-mm thick back panel can be customised in the various finishes available in Cesar's palette. The shelf can be supplied with a shelf overlay but only in the natural stone and engineered stone finishes.

03\_ DressUp Line's length (L\*) can vary from a minimum of 60 cm to a maximum of 3.9 metres.

04\_For back panels and shelf overlays in natural stone, engineered stone, Inalco ceramics and Dekton, please check for dimensional restrictions of materials.

06\_The height (H\*) of the back panel can vary depending on the height restrictions of the material used.

07\_If accessories are hung from the shelf, the minimum distance between them and the top must be greater or equal to 50 cm.

08\_Led lighting is available for both sides of the shelf or just for one

## DRESSUP LINE

Wall Solution

Design by García Cumini

### • OPTIONAL ELEMENTS

#### SMALL ACCESSORY HOLDER

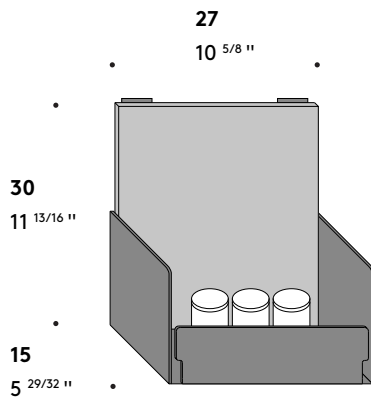

#### BIG ACCESSORY HOLDER

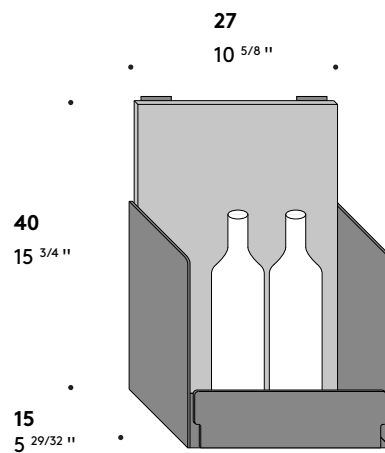

#### SQUARE HOOK



#### CURVED HOOK



#### CLOTHES HOOK

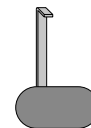

#### STEMWARE RACK for glass shelves

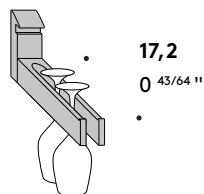

### • FINISHES

#### STRUCTURE

Black anodised aluminium  
Champagne anodised aluminium  
Bronze anodised aluminium

#### BACK PANEL

Oak wood veneers (all)  
Elm veneers (all)

#### STEMWARE RACK

Rovere Corvino

## DRESSUP LINE

Wall Solution

Design by García Cumini

- **EDGE FINISHES**

Anodised ribbed black  
Anodised ribbed Champagne  
Anodised ribbed bronze

.....

- **BACK PANEL FINISHES**

Melamine  
Technomat  
Technogloss  
Fenix  
Unicolor HPL  
Gloss and silk-effect lacquers  
Structured lacquers  
Wood veneers  
Metallic effect lacquers  
Metals  
Ceramics (\*)  
Natural stone  
Engineered stone

(\*)

Supplied with an edging frame in the same colour as the shelf.  
The edges of all the other back panels are in the same finish as  
the back panel.

.....

- **SHELF OVERLAY FINISHES**

Natural stone  
Engineered stone

**IMPORTANT:**

Notes, dimensions and finishes are indicative



# C E S A R

## DRESSUP LINE

Wall Solution

Design by García Cumini

- EXAMPLES OF DRESSUP LINE + DRESSUP ARRANGEMENTS

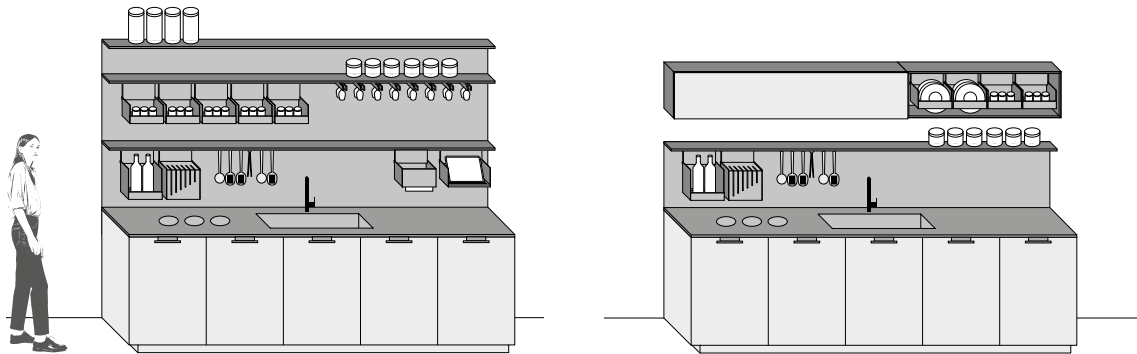
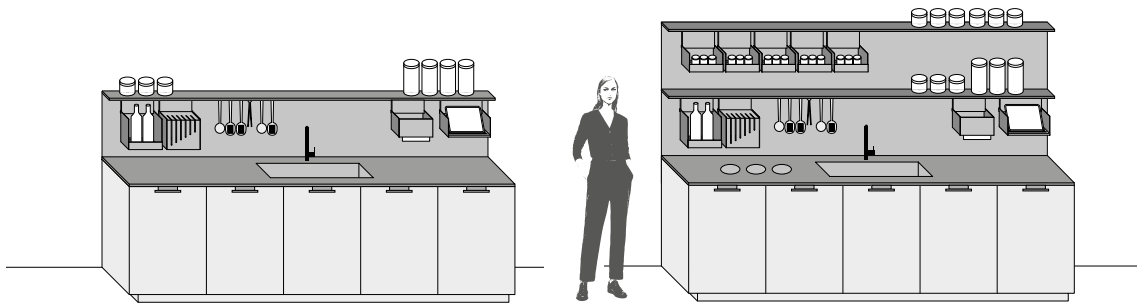

# C E S A R

## DRESSUP LINE

Wall Solution

Design by García Cumini

- EXAMPLES OF DRESSUP LINE + DRESSUP ARRANGEMENTS

